



SiGe HBT GAIN BLOCK MMIC AMPLIFIER, DC - 5 GHz

Typical Applications

The HMC482ST89 / HMC482ST89E is an ideal RF/IF gain block & LO or PA driver for:

- Cellular / PCS / 3G
- Fixed Wireless, WLAN & WiMAX
- CATV, Cable Modem & DBS
- Microwave Radio & Test Equipment

Features

- P1dB Output Power: +22 dBm
- Gain: 20 dB
- Output IP3: +36 dBm
- Cascadable 50 Ohm I/Os
- Single Supply: +6V to +12V
- Industry Standard SOT89 Package
- Included in the HMC-DK001 Designer's Kit

Functional Diagram

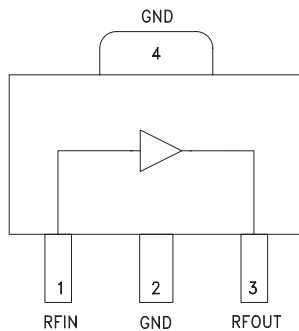

General Description

The HMC482ST89 & HMC482ST89E are SiGe Heterojunction Bipolar Transistor (HBT) Gain Block MMIC SMT amplifiers covering DC to 5 GHz. Packaged in an industry standard SOT89, the amplifier can be used as a cascadable 50 Ohm RF/IF gain stage as well as a LO or PA driver with up to +24 dBm output power. The Darlington feedback pair results in reduced sensitivity to normal process variations and excellent gain stability over temperature while requiring a minimal number of external bias components.

Electrical Specifications, $V_s = 8.0\text{ V}$, $R_{bias} = 27\text{ Ohm}$, $T_A = +25^\circ\text{ C}$

Parameter		Min.	Typ.	Max.	Units
Gain	DC - 1.0 GHz	17	19		dB
	1.0 - 2.0 GHz	15	17		dB
	2.0 - 3.0 GHz	12.5	14.5		dB
	3.0 - 4.0 GHz	10	12		dB
	4.0 - 5.0 GHz	8	10		dB
Gain Variation Over Temperature	DC - 5 GHz		0.008	0.016	dB/ °C
Input Return Loss	DC - 1.0 GHz		15		dB
	1.0 - 5.0 GHz		18		dB
Output Return Loss	DC - 1.0 GHz		20		dB
	1.0 - 3.0 GHz		14		dB
	3.0 - 4.0 GHz		12		dB
	4.0 - 5.0 GHz		8		dB
Reverse Isolation	DC - 5 GHz		16		dB
Output Power for 1 dB Compression (P1dB)	0.5 - 1.0 GHz	19.5	22.5		dBm
	1.0 - 2.0 GHz	17	20		dBm
	2.0 - 3.0 GHz	14.5	17.5		dBm
	3.0 - 4.0 GHz	12.5	15.5		dBm
	4.0 - 5.0 GHz	10.5	13.5		dBm
Output Third Order Intercept (IP3) ($P_{out} = 0\text{ dBm}$ per tone, 1 MHz spacing)	0.5 - 1.0 GHz		36		dBm
	1.0 - 2.0 GHz		35		dBm
	2.0 - 3.0 GHz		32		dBm
	3.0 - 4.0 GHz		30		dBm
	4.0 - 5.0 GHz		28		dBm
Noise Figure	DC - 2.0 GHz		4		dB
	2.0 - 4.0 GHz		5		dB
	4.0 - 5.0 GHz		5.5		dB
Supply Current (I_{cq})			110		mA

Note: Data taken with broadband bias tee on device output.



**SiGe HBT GAIN BLOCK
MMIC AMPLIFIER, DC - 5 GHz**

Broadband Gain & Return Loss

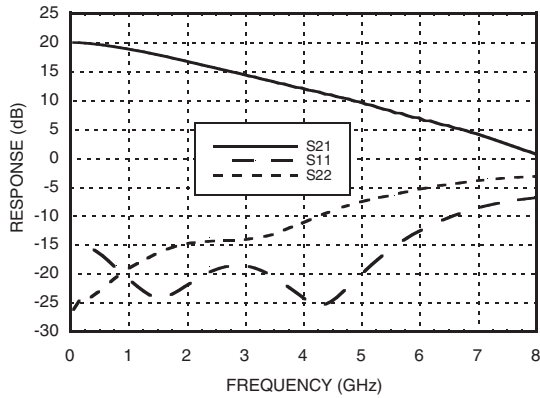

Gain vs. Temperature

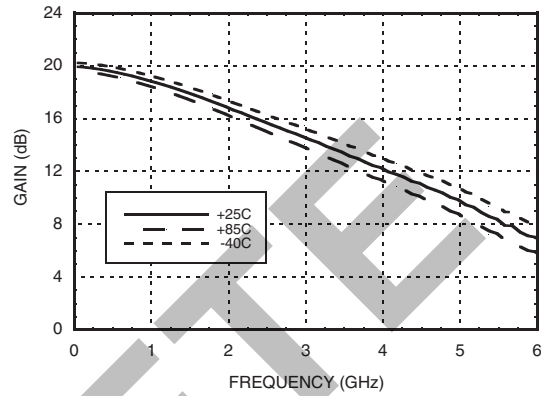

Input Return Loss vs. Temperature

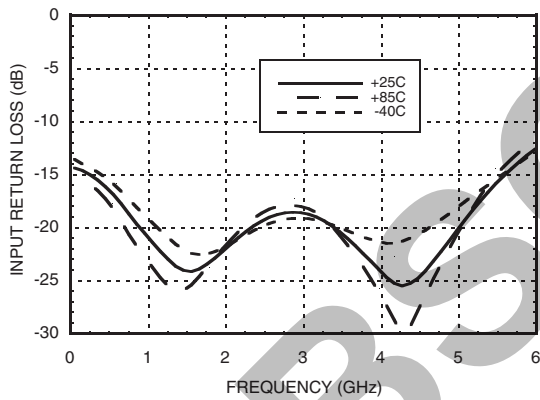

Output Return Loss vs. Temperature

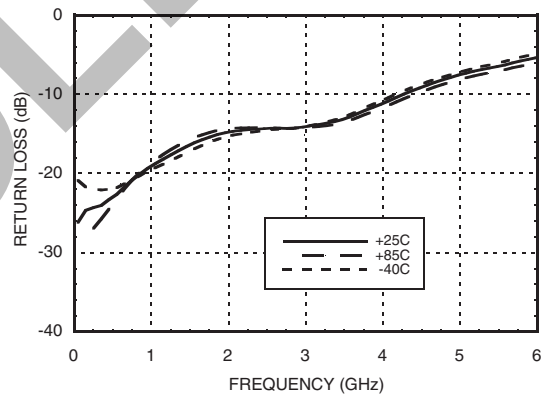

Reverse Isolation vs. Temperature

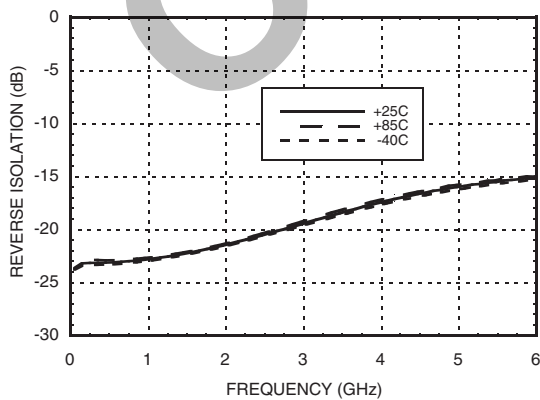

Noise Figure vs. Temperature

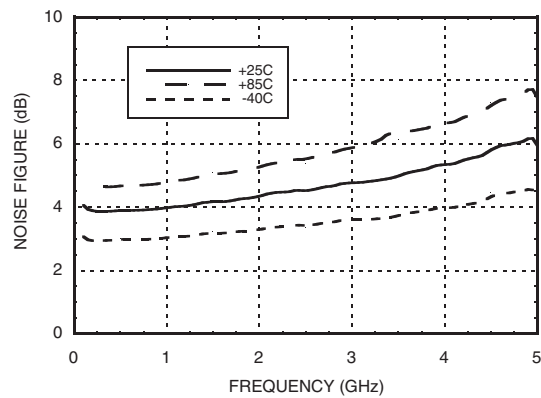

Information furnished by Analog Devices is believed to be accurate and reliable. However, no responsibility is assumed by Analog Devices for its use, nor for any infringements of patents or other rights of third parties that may result from its use. Specifications subject to change without notice. No license is granted by implication or otherwise under any patent or patent rights of Analog Devices. Trademarks and registered trademarks are the property of their respective owners.

For price, delivery, and to place orders: Analog Devices, Inc., One Technology Way, P.O. Box 9106, Norwood, MA 02062-9106 Phone: 781-329-4700 • Order online at www.analog.com Application Support: Phone: 1-800-ANALOG-D



**SiGe HBT GAIN BLOCK
MMIC AMPLIFIER, DC - 5 GHz**

P1dB vs. Temperature

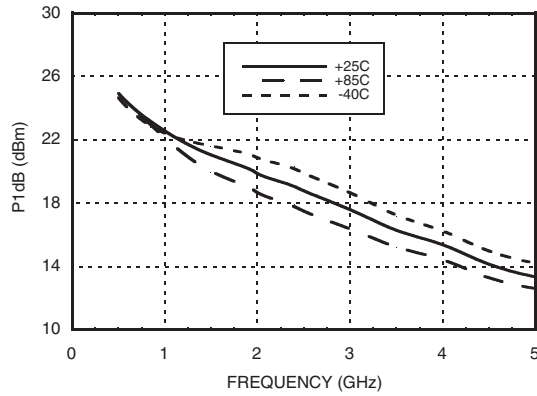

Psat vs. Temperature

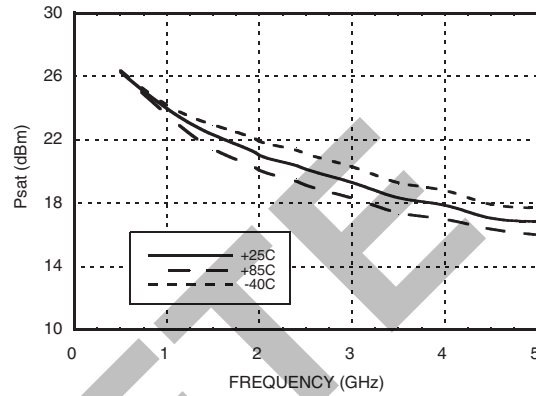

Output IP3 vs. Temperature

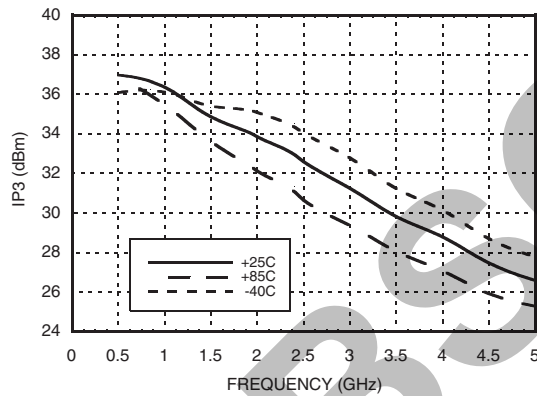

**Gain, Power & OIP3 vs. Supply Voltage
for Constant Icc= 110 mA @ 850 MHz**

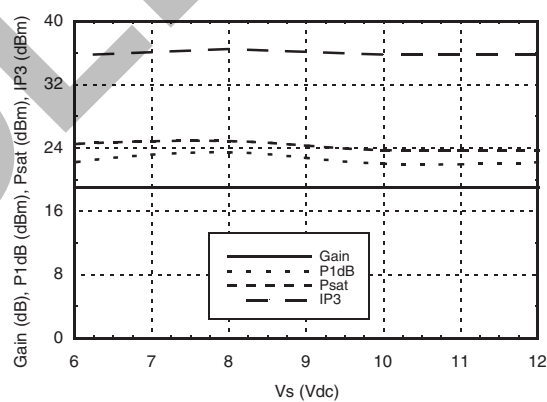

**Vcc vs. Icc Over Temperature for
Fixed Vs= 8V, RBIAS= 27 Ohms**

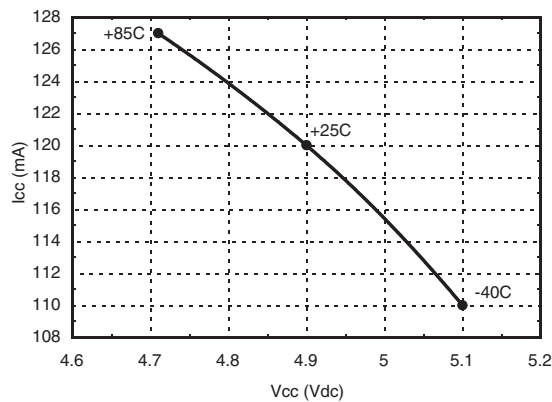



SiGe HBT GAIN BLOCK MMIC AMPLIFIER, DC - 5 GHz

Absolute Maximum Ratings

Collector Bias Voltage (Vcc)	+6.0 Vdc
RF Input Power (RFIN)(Vcc = +5 Vdc)	+14 dBm
Junction Temperature	150 °C
Continuous P _{diss} (T = 85 °C) (derate 14.5 mW/°C above 85 °C)	0.94 W
Thermal Resistance (junction to lead)	69 °C/W
Storage Temperature	-65 to +150 °C
Operating Temperature	-40 to +85 °C
ESD Sensitivity (HBM)	Class 1A



ELECTROSTATIC SENSITIVE DEVICE
OBSERVE HANDLING PRECAUTIONS

Outline Drawing

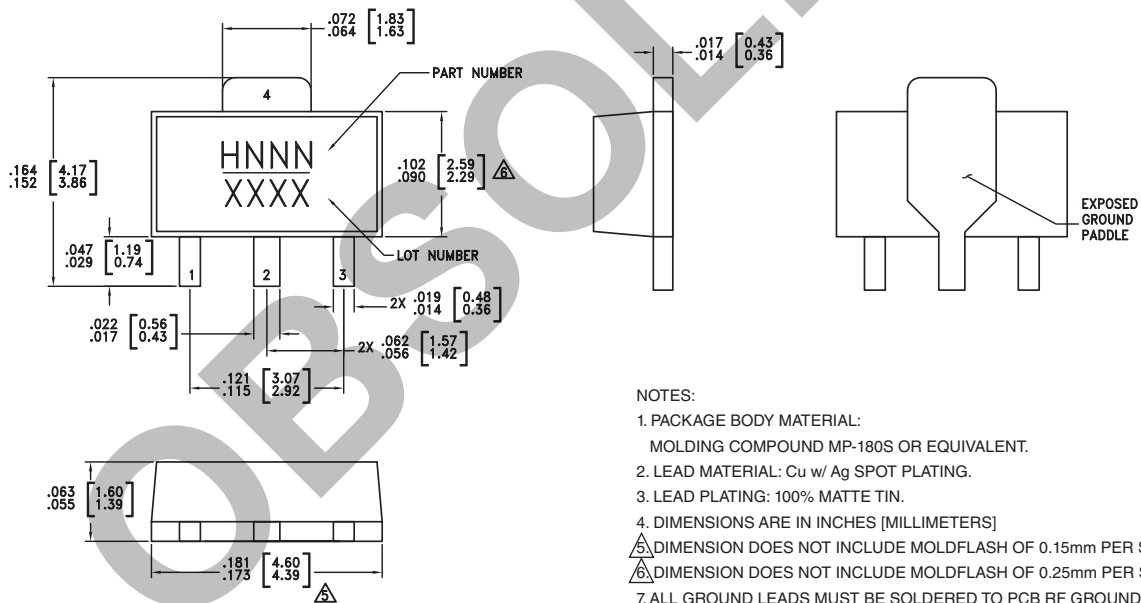

NOTES:

- PACKAGE BODY MATERIAL:
MOLDING COMPOUND MP-180S OR EQUIVALENT.
- LEAD MATERIAL: Cu w/ Ag SPOT PLATING.
- LEAD PLATING: 100% MATTE TIN.
- DIMENSIONS ARE IN INCHES [MILLIMETERS]
- DIMENSION DOES NOT INCLUDE MOLDFLASH OF 0.15mm PER SIDE.
- DIMENSION DOES NOT INCLUDE MOLDFLASH OF 0.25mm PER SIDE.
- ALL GROUND LEADS MUST BE SOLDERED TO PCB RF GROUND.

Package Information

Part Number	Package Body Material	Lead Finish	MSL Rating	Package Marking ^[3]
HMC482ST89	Low Stress Injection Molded Plastic	Sn/Pb Solder	MSL1 ^[1]	H482 XXXX
HMC482ST89E	RoHS-compliant Low Stress Injection Molded Plastic	100% matte Sn	MSL1 ^[2]	<u>H482</u> XXXX

[1] Max peak reflow temperature of 235 °C

[2] Max peak reflow temperature of 260 °C

[3] 4-Digit lot number XXXX

SiGe HBT GAIN BLOCK MMIC AMPLIFIER, DC - 5 GHz



Pin Descriptions

Pin Number	Function	Description	Interface Schematic
1	RFIN	This pin is DC coupled. An off chip DC blocking capacitor is required.	
3	RFOUT	RF output and DC Bias (Vcc) for the output stage.	
2, 4	GND	These pins and package bottom must be connected to RF/DC ground.	

Application Circuit

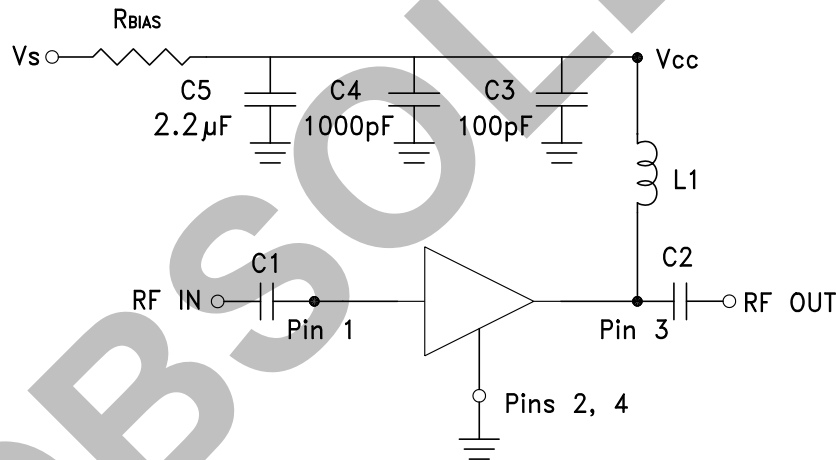

Recommended Bias Resistor Values for $I_{cc} = 110 \text{ mA}$, $R_{bias} = (V_s - V_{cc}) / I_{cc}$

Supply Voltage (Vs)	6V	8V	10V	12V
RBIAS VALUE	9.1 Ω	27 Ω	47 Ω	62 Ω
RBIAS POWER RATING	1/4 W	1/2 W	1 W	1.5 W

Note:

- External blocking capacitors are required on RFIN and RFOUT.
- RBIAS provides DC bias stability over temperature.

Recommended Component Values for Key Application Frequencies

Component	Frequency (MHz)						
	50	900	1900	2200	2400	3500	5000
L1	270 nH	56 nH	18 nH	18 nH	15 nH	8.2 nH	6.8 nH
C1, C2	0.01 μF	100 pF	100 pF	100 pF	100 pF	100 pF	100 pF



**SiGe HBT GAIN BLOCK
MMIC AMPLIFIER, DC - 5 GHz**

Evaluation PCB

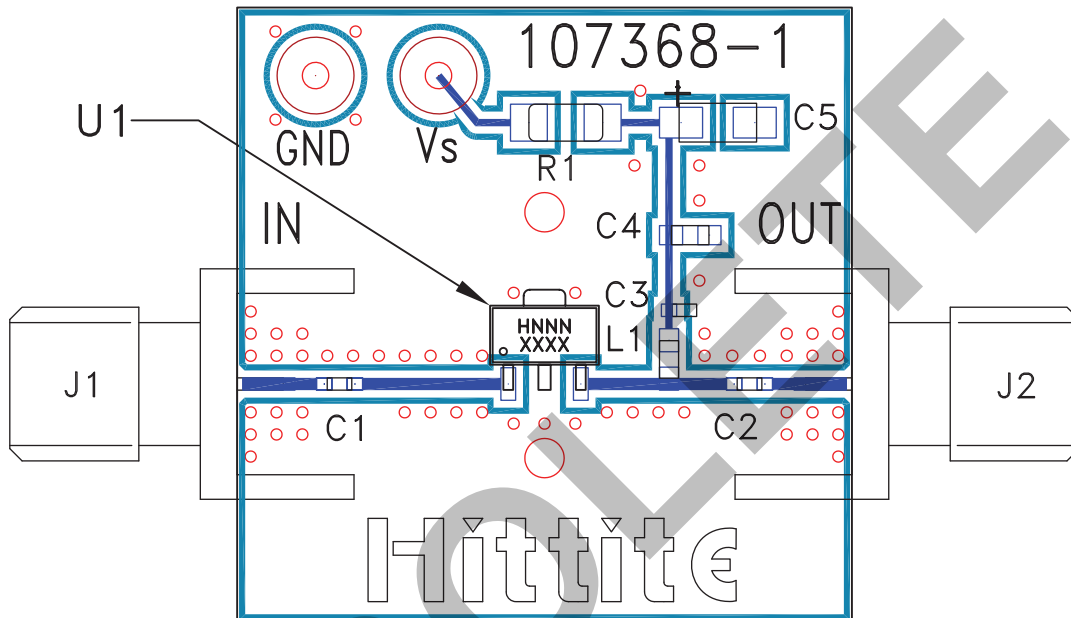

List of Materials for Evaluation PCB 109026 [1]

Item	Description
J1 - J2	PCB Mount SMA Connector
J3 - J4	DC Pin
C1, C2	Capacitor, 0402 Pkg.
C3	100 pF Capacitor, 0402 Pkg.
C4	1000 pF Capacitor, 0603 Pkg.
C5	2.2 μ F Capacitor, Tantalum
R1	Resistor, 1210 Pkg.
L1	Inductor, 0603 Pkg.
U1	HMC482ST89 / HMC482ST89E
PCB [2]	107368 Evaluation PCB

[1] Reference this number when ordering complete evaluation PCB

[2] Circuit Board Material: Rogers 4350

The circuit board used in the final application should use RF circuit design techniques. Signal lines should have 50 Ohm impedance while the package ground leads and package bottom should be connected directly to the ground plane similar to that shown. A sufficient number of via holes should be used to connect the top and bottom ground planes. The evaluation board should be mounted to an appropriate heat sink. The evaluation circuit board shown is available from Hittite upon request.